



PIPE TOOLS & VISES
SINCE 1896

Applies to: 08510



USER MANUAL

RG26 Series ROLL GROOVER

Includes: RG26S and
discontinued RG26CU

Operation, Maintenance and Service Instructions

REED MANUFACTURING

1425 West 8th Street Erie, PA 16502 USA Phone: 800-666-3691 or +1 814-452-3691 Fax: +1 814-455-1697 reedsales@reedmfgco.com

www.reedmfgco.com

0823-50356



IMPORTANT:

Read and fully understand this operating manual before operating or performing maintenance on the RG26 Roll Groover. It is essential to properly train and review with operating personnel to become familiar with the tool's operations, applications, and limitations to prevent possible bodily injury and property damage. All personnel should be aware of the tool's specific hazards.

**REED RG26 Series Roll Groover
Description and Specifications**

Description

The REED **RG26S** Roll Groover is designed to form standard rolled grooves in steel, stainless steel, PVC, and aluminum pipe in 2-6" schedule 10, and 2-3" schedule 40. The REED **RG26CU** Roll Groover (discontinued) is designed to form standard rolled grooves in 2" to 6" copper tubing.

The groove is formed by a groove roll which is fed into the pipe wall. The pipe is supported by a drive roll, which is relieved to permit pipe wall deformation. The formed grooves comply with the specifications required for mechanical coupling systems. The only adjustment required is for the depth of the groove.

Designed for ease of use and portability, the RG26 Series Roll Groover provides a practical solution for manual on-site and in-place roll grooving.

Specifications

Capacity RG26S	2" - 6" Schedule 10 2" - 3" Schedule 40
Capacity RG26CU	2" - 6" K,L,M, and DWV Copper
Depth Adjustment	Adjusting Nut, Depth Gauges (included), and Jam Nuts
Actuation	Crank Nut and Ratcheting Crank Handle (included)
Weight	21 lbs (9.55 kg)

Recommended Accessories

- REED R450+ Tripod, Field Pipe Vise, CV6 bench mounted chain vise, or #64 yoke pipe vise (when not using in-place)
- REED Pipe Jack (for long pipe lengths)

Important - Before Operating

Before operating the RG26 Roll Groover, read and follow all safety information in the User Manual.

Safety Information



WARNING !

Serious injury can occur if all safety information and operating instructions are not followed. These injuries could include:

Loss of fingers, hands, arms or other body parts if clothing or gloves get caught in moving parts.

Impact injuries, including broken bones if roll groover or workpiece falls.

Wear eye protection to prevent eye injuries by thrown workpiece or workpiece chips.

General Safety

Read and follow the safety information and instructions in the user manual. Store the user manual in a clean area and always at a readily available location.

Personal Safety

1. **Wear snug-fitting clothes, safety shoes, hard hat and safety glasses.** Cover up or tie up long hair. Do not wear loose clothing, gloves, unbuttoned jackets, loose sleeve clothes, neckties, rings, watches or other jewelry.
2. Keep good footing and balance. Do not overreach. Keep hands and tools away from moving parts of the roll groover.

Work Area Safety

1. Keep children and visitors out of the work area. If visitors must be in the area, keep them far away from the machine. Keep working environment clear at all times. When using this tool at elevated locations or for overhead grooving, keep area below clear of other personnel.
2. Keep work area clean, uncluttered and well lighted.
3. Keep floors dry and free of slippery materials.



Roll Groover Safety

1. When operating, keep hands away from grooving rolls. Fingers could get caught between the groove roll and drive shaft.
2. When setting up and using, make sure the Roll Groover is secured to the pipe. Carefully follow set-up instructions.
3. Do not use the Roll Groover for any other purpose than roll grooving pipe and tubing.
4. Do not use excessive force in turning the feed nut. Follow operating instructions.
5. Be sure pipe or tubing is secure in a pipe vise or securely hung in-place. Support long lengths of pipe or tubing with a pipe jack.
6. Use recommended accessories. Use of other accessories may increase the risk of injury. Refer to the recommended accessories section in the front of this manual.

Machine Maintenance

1. Inspect the equipment. Prior to using the tool, check the movable parts for any obstructions. Be certain that all tool parts are properly installed and secured
2. Inspect groove roll and drive shaft. Replace when necessary.
3. Lubricate with multi-purpose grease through the three grease fittings.
4. Keep the ratcheting crank handle dry and clean.

CAUTION

This tool is designed for manual operation only. This tool is not to be driven by any power drive devices. The use of power drive devices may present risk to the operator and cause damage to the tool.

CAUTION

When using this tool at elevated locations, the area below must be kept clear of other personnel.

RG26 tools are individually packaged in heavy cardboard containers. Upon receipt, check to be certain the tool is the correct model and all necessary parts are included. Included should be:

- (1). RG26 tool
- (1). Set of depth gauges (attached to tool)
- (1). Ratcheting crank with 1 1/4" socket
- (1). User Manual

If incomplete, contact your REED Distributor or Reed Manufacturing.

Tube/Pipe Preparation

For satisfactory tool operation, the following tube/pipe preparation tips should be carefully observed:

1. Tube/pipe must be square cut. Do not use a cutting torch. **Note:** When adjusting for roll groover depth, the trial groove pipe should not have a large burr protruding inward. Use a suitable tool for deburring the pipe or tubing. After the groove depth has been set, deburring of the pipe is not required.
2. The end of the tube/pipe, both inside and out, should be cleaned of coarse scale, dirt or other materials which might interfere with or damage the grooving rolls or distort the groove. Large weld beads are to be ground to permit smooth rolling operation.

Pipe Set-Up

The RG26 is an orbital roll grooving tool which rotates around a pipe held stationary. The pipe may be held in a pipe vise during grooving. The RG26 also grooves piping in a depressurized, in-place piping system.

Pipe Vise Set-Up

The choice of grooving location in the shop or field should take into account the following factors:

- Pipe handling requirements
- Working space requirements for the tool and pipe
- Anchoring requirements for the pipe vise

Procedure

1. Securely mount pipe vise (chain type) on a secure stand or workbench. Pipe vise should be mounted flush with or overhang the edge of the stand or workbench so, when the tool is mounted on the pipe, the tool will rotate freely around the pipe and not be obstructed by the bench or stand.

2. Secure pipe in pipe vise, anchored to hold securely the weight of the tool (21 lbs.) 9.5 kg. Position the pipe to overhang the pipe vise approximately 5 - 12" (127 - 305 mm) so the tool can rotate in an unobstructed manner. (See Fig. 1.)



Fig. 1. Pipe Set-up

Groove-In-Place Set-Up

Previously installed piping may be grooved with the RG26, providing the piping is securely supported.

NOTE: Pipe hangers must be able to accommodate the weight of the 21 lb. (9.55 kg) RG26 plus the manual effort to operate the tool (approximately 20 ft.-lb. torque) during grooving.

WARNING

Piping systems must always be depressurized and drained before attempting disassembly. Failure to do so could result in serious injury, property damage, joint leakage or joint separation.

Mounting Tool

1. Retract the upper roller fully by turning the brass feed nut counterclockwise.
2. With the hex drive nut down, insert the nose of the body into the pipe end. Push the tool onto the pipe until the pipe end stops rest against the pipe end. (See Fig 2.)
3. Draw rolls together by turning the brass feed nut clockwise. Continue tightening until the grooving rolls are in light, but firm contact with the pipe.

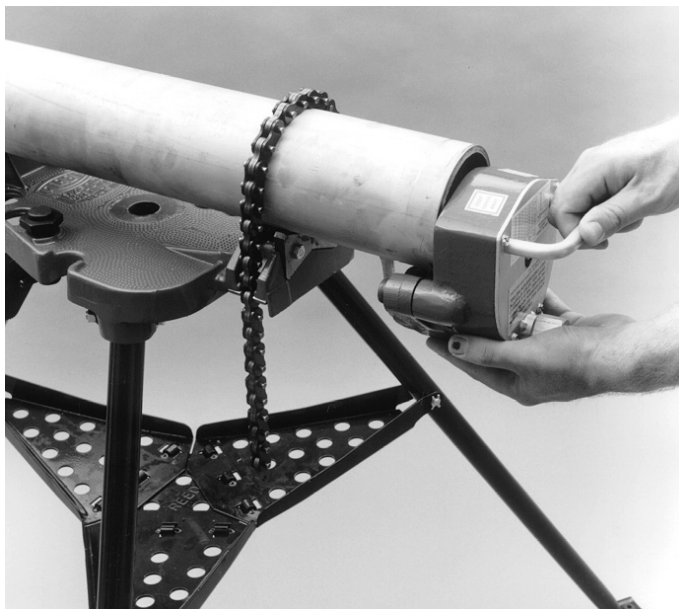

Fig. 2. Tool Insertion

Adjusting Groove Depth

The Depth Stop Collars must be adjusted for each tube/pipe size or change in wall thickness. Groove diameter, identified as the "C" dimension for each tube/pipe size, is listed under Standard Roll Groove Specifications - Steel and Other IPS Pipe. For convenience, a "C" Diameter Chart for the most common pipe sizes is also on the tool.

1. Unlock the depth stop collars by turning them in opposite directions until they are separated.
2. Locate the groove depth gauge attached to the tool which is identified with the pipe size to be grooved. Turn the depth stop collar, closest to the trunnion, until the distance between the collar and the top of the trunnion is equal to the groove depth gauge thickness. Use the groove depth gauge like a feeler gauge. (See Figure 3.)



Fig. 3. Setting Gauge Depth

3. Turn the second collar until both are locked firmly against one another, maintaining the gap set with the feeler gauge. Replace the depth gauges back into the holder.
4. Prepare a trial groove by tightening the brass feed nut the recommended turn increment, and then by turning the crank nut clockwise until the roll groover has made one full revolution around the pipe. (See Fig. 4.)

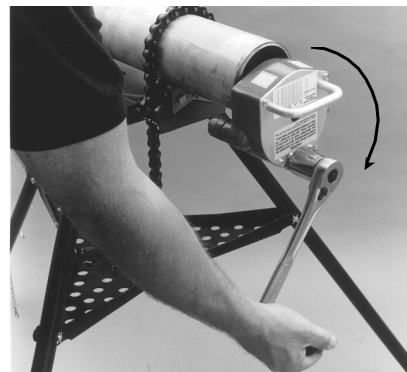

Fig. 4. Turning



5. Continue turning the feed nut and cranking the tool around the pipe. Once the jam nuts rest against the trunnion, continue to crank the tool around for one more revolution. (See Fig. 5.)

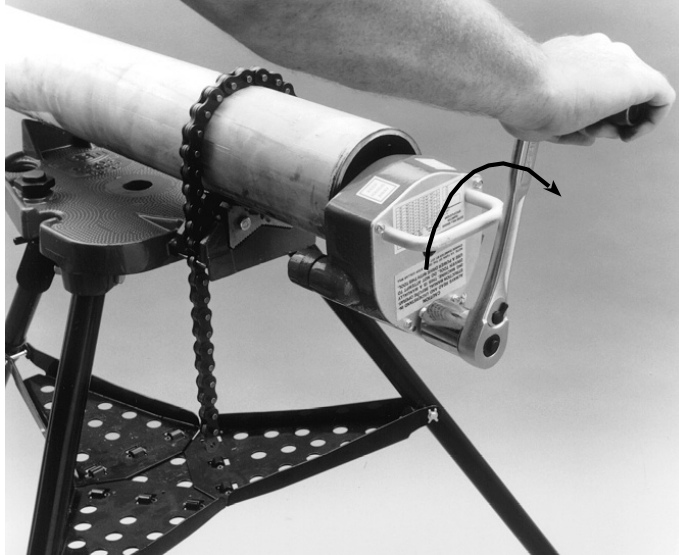

Fig. 5. Turning crank handle

Note: Trial groove pipe should be deburred for best results. A burr on the inside of the pipe will raise the pipe away from the drive shaft, causing inaccurate set-up adjustment. After proper groove depth has been verified by the trial groove, deburring of the following pipes is not required. See Step 1 of “Tube/Pipe Preparation”

6. After a trial groove is prepared and the tool is removed from the pipe, carefully check the groove diameter (“C” dimension), a charted under Standard Roll Groove Specifications - Steel and Other IPS Pipe, page 8, and Drawn Copper Tubing Groove Specifications, page 9. The “C” dimension is best checked with a pipe tape. It may also be checked with a dial caliper or narrow land micrometer at two locations, 90° apart, around the groove. The average reading must equal the required Groove Diameter.

7. If groove diameter (“C” dimension) is not within tolerance, adjust the depth stop collars to obtain the proper dimension. To adjust for a smaller groove diameter, turn the depth stop collars counterclockwise. To adjust for a bigger groove diameter, turn collars clockwise. A quarter turn either way will change the groove diameter by .017” (.068” per full turn).

8. Prepare another trial groove and check the groove diameter again. Repeat Steps 6 and 7 until groove diameter is within specification.

Grooving Operation

NOTE: REED RG26 tool is designed only for roll grooving tube/pipe of the appropriate sizes. Grooving of tube/pipe other than that recommended may not produce grooves of proper tube/pipe end configuration or groove dimensions necessary for joining.

Before Grooving:

- Review Safety Precautions before operating the tool.
- Check to be certain tube/pipe has been prepared properly as detailed in *Tube/Pipe Preparation*.
- Check to be certain pipe is properly supported as detailed in *Pipe Set-Up*.
- Check to be certain the tool is properly mounted on the pipe. See *Mounting Tool*.
- Check to be certain the depth stop collar is adjusted correctly. See *Adjusting Groove Depth*.

CAUTION

The “C” Dimension (groove diameter) must always conform to specifications under Standard Roll Groove Specifications, page 9, to ensure proper joint performance. Failure to do so could result in personal injury, property damage, improper installation, joint leakage or joint failure.

CAUTION

Keep fingers, clothes, hair and objects other than tube/pipe away from the rotating tool. Use safety glasses, hardhat and appropriate footwear. Failure to do so could result in personal injury.

1. Advance the feed by turning the feed nut clockwise by the amount show in Table 1. Feed rates for the RG26 vary depending on material and pipe wall thickness.

Material	Wall Thickness inches/(mm)	Turns of Feed Screw to Advance the Feed
Steel and Stainless Steel	.135 to .216 (3.43 to 5.49)	1/4 turn
	.120 to .134 (3.05 to 3.40)	1/3 turn
	.065 to .119 (1.65 to 3.02)	1/2 turn
Aluminum and Copper	.135 to .216 (3.43 to 5.49)	1/3 turn
	.120 to .134 (3.05 to 3.40)	1/2 turn
	.065 to .119 (1.65 to 3.02)	2/3 turn
PVC	.154 to .258 (3.91 to 6.55)	3/4 turn

Table 1 - Feed Rates

Note: Over-tightening (overfeeding) will result in shortened bearing life and other tool damage. Over or under-tightening could result in the tool “walking” off the pipe and eventually becoming disengaged from the pipe.

2. Place the ratcheting crank handle onto the drive hex. Crank the drive hex nut clockwise until the tool travels one full turn around the tube/pipe.
3. Advance the feed by turning the brass feed nut clockwise by the amount show in Table 1. Crank the tool another full turn around the pipe.
4. Continue grooving by advancing the feed (Table 1) and cranking the groover around the tube/pipe until the depth stop collar comes in contact with the trunnion. At this point, the brass feed nut can no longer be tightened. Crank the tool at least one more full turn around the tube/pipe after full groove depth is achieved.

5. After dismounting tool from pipe (see below), check groove depth to ensure groove meets groove depth specification. NOTE: Groove Diameter should be correct for the diameter and wall thickness of tube/pipe for which it was set under Groove Diameter Stop Setting procedures. Groove diameter should be checked periodically and adjusted as necessary.

Dismounting The Tool

1. Crank the tool until the drive hex is located in the down position.
2. Turn the feed nut counterclockwise to retract the upper roll arm to the full open position.
3. Lift the tool and remove it from the pipe. (See Fig. 6.)

Maintenance

1. Keep tool clean for best and safest performance.
2. Lubrication:
 - a) After approximately eight hours of operation, grease the bearings at the three grease fittings on the tool. Use a No. 2 EP Lithium base grease.
 - b) Weekly apply a light oil (SAE 10W-30 or equivalent) to the threads where the feed screw passes through the feed nut. Also, oil should be applied to the shoulder bolts which hold the roll arm to the body, the feed screw to the roll arm, and at the trunnion pivots.

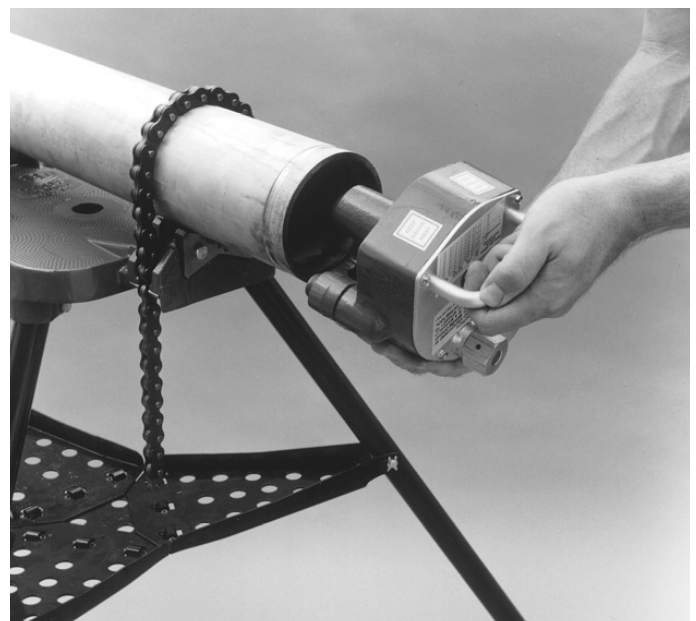

Fig. 6. Dismounting the tool.



Trouble Shooting

Problem	Cause	Solution
Unable to close rolls onto pipe.	Improper adjustment of depth stop collars.	Turn depth stop collars counterclockwise, away from trunnion and reset depth stop collar, as described in “Adjusting The Groove Depth.”
Groove too deep (groove diameter too small).	Improper adjustment of depth stop collars.	Reset depth stop collars as described in “Adjusting Groove Depth.”
Groove too shallow (groove diameter too large).	Improper adjustment of depth stop collars.	Reset depth stop collars as described in “Adjusting Groove Depth.”
Tool does not move when cranked.	Rust or dirt has built up on lower roll. Worn grooving rolls.	Remove accumulation from lower roll with stiff wire brush. Inspect lower roll for worn knurls, replace if worn.
Tool wobbles during cranking.	Variation in pipe wall thickness or inadequate feed rate.	Advance the feed at the rates described in Table 1.
Tool won't track (walks or falls off pipe).	Tool is not correctly positioned on pipe. Pipe end out of square. Excessive fall off at pipe end from use of pipe cutter with improper feed rate. Tool crank turned in wrong direction.	Reposition tool with pipe end stops against pipe. Trim pipe to square pipe end (see tube/pipe preparation). Advance the feed at the rates described in Table 1. Turn feed and crank nuts clockwise.
Tool won't groove tube/pipe.	Tube/pipe beyond tool's wall thickness capability. Tube/pipe material excessively hard.	See rating charts. Use recommended pipe material.

RG26S Roll Groove Diameter Specifications

NOM. PIPE SIZE	PIPE O.D.	A GASKET SEAT + .030	B GROOVE WIDTH + .030	C GROOVE DIAMETER	
				O.D.	TOL. (+.000)
2	2.375	.625	.344	2.250	-.015
2-1/2	2.875	.625	.344	2.720	-.018
3 OD	3.00	.625	.344	2.845	-.018
3	3.50	.625	.344	3.344	-.018
3-1/2	4.00	.625	.344	3.834	-.020
4	4.50	.625	.344	4.334	-.020
4-1/2	5.00	.625	.344	4.834	-.020
5	5.563	.625	.344	5.395	-.022
6 OD	6.00	.625	.344	5.830	-.022
6	6.625	.625	.344	6.455	-.022

RG26CU Roll Groove Diameter Specifications (Discontinued)

NOM. PIPE SIZE	PIPE O.D.	A GASKET SEAT ±.030	B GROOVE WIDTH ±.030	C GROOVE DIAMETER
				O.D. TOL. (+.000/-.020)"
2	2.125	0.610	0.300	2.029
2 1/2	2.625	0.610	0.300	2.525
3	3.125	0.610	0.300	3.025
4	4.125	0.610	0.300	4.019
5	5.125	0.610	0.300	4.999
6	6.125	0.610	0.300	5.999

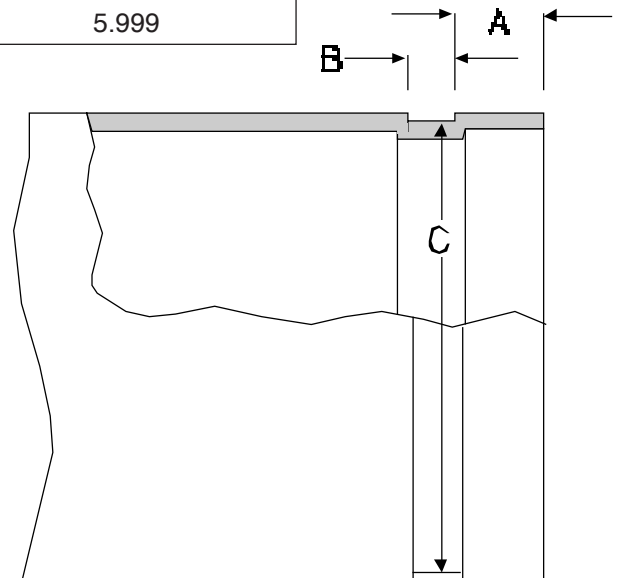



Parts List

Ref. No.	Description	RG26S	RG26CU
		#08510 Item Code	Discontinued 2012, replacement parts only #08512 Item Code
1	Main Body	98520	98565
2	Yoke	98521	98521
3	Crank Assembly	98522	98522
4	Drive Shaft	98523	98523
5	Drive Shaft Gear	98524	98524
6	Crank Shaft Gear	98525	98525
7	Crank Shaft	98526	98526
8	Feed Screw	98527	98527
9	Groove Roll Shaft	98528	98528
10	Groove Roll	98529	98550
11	Cover Plate Assembly	98542	98542
12	Jam Nut	98531	98531
13	Drive Roll	98532	98551
14	Crank Nut	98534	98534
15	Feed Nut	98535	98535
16	Trunnion	98536	98536
17	Trunnion Plate	98537	98537
18	Depth Gauge Set	98549	98566
19	Thrust Button	98538	98538
20	Knurled Pin	98539	98539
21	Handle	98540	98540
22	Bronze Bushing	40461	40461
23	Bronze Bushing	40473	40473
24	Washer Large	40462	40462
25	Washer Small	40463	40463
26	Groove Pin	98570	98570
27	Grease Fitting	40338	40338
28	Roller Bearing	40459	40459
29	Roller Bearing	40460	40460
30	Needle Roller Bearing	40458	40458
31	Roll Pin	30232	30232
32	Roll Pin	30233	30233
33	Flat Head Socket Screw	30216	30216
34	Dowel Pin	30218	30218
35	Retaining Ring	30219	30219
36	Socket Set Screw	30224	30224
37	Shoulder Screw	30228	30228
38	Shoulder Screw	30229	30229
39	Shoulder Screw	30227	30227
40	Lock Nut	30231	30231
41	Hex Machine Screw	30225	30225
42	Socket Head Cap Screw	30230	30230
43	Trunnion/Feed Nut Assembly	98568	98568
44	Gauge Bracket	98545	98545
45	Spring Plunger	40318	40318
46	Socket Head Cap Screw	39200	39200

See also RP-44

Replacement Parts

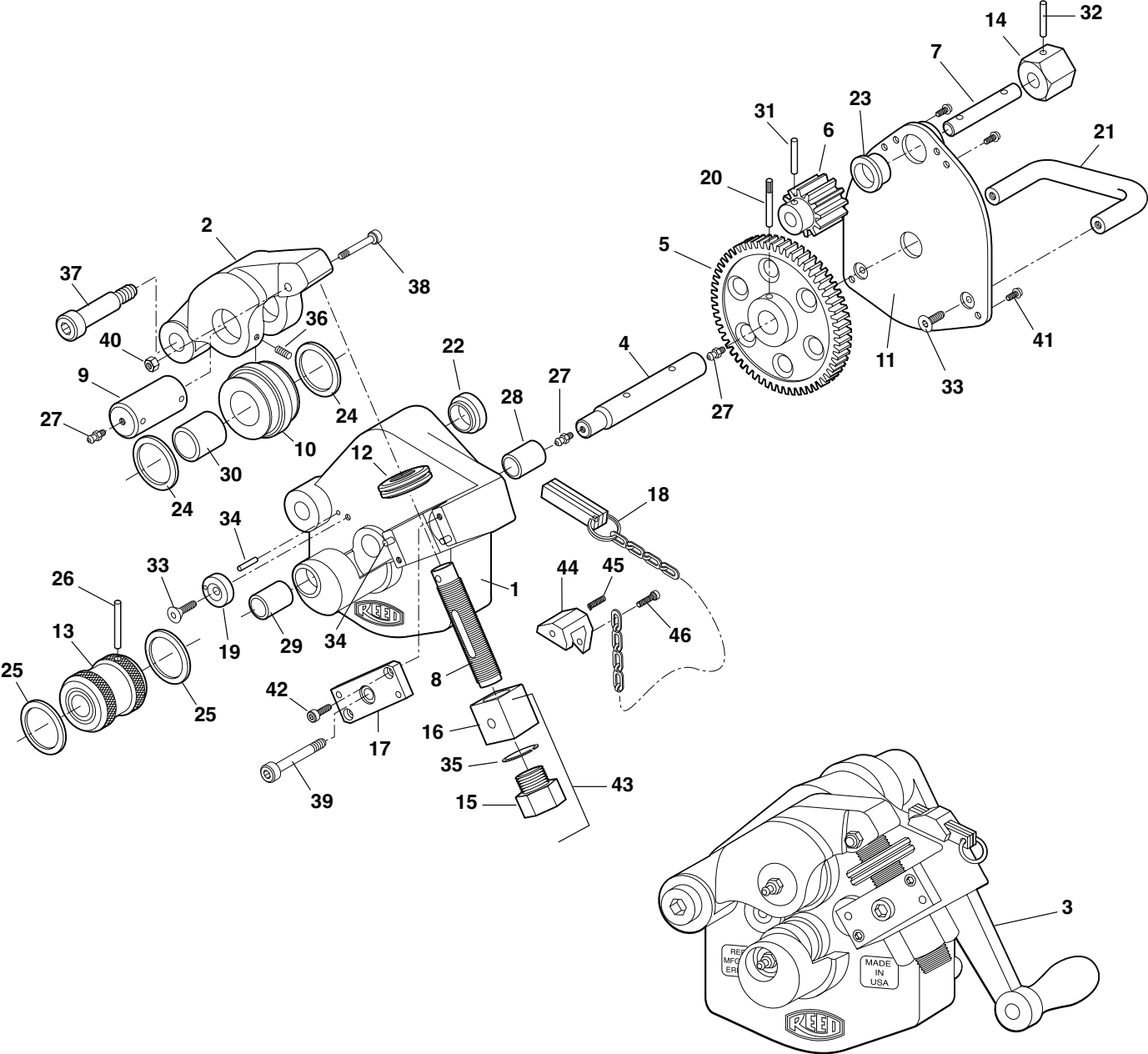

See also RP-44



REED Warranty

REED will repair or replace tools with any defects due to faulty materials or workmanship for one (1) year or five (5) years from the date of purchase, as applicable. This warranty does not cover part failure due to tool abuse, misuse, or damage caused where repairs or modifications have been made or attempted by non REED authorized repair technicians. This warranty applies only to REED tools and does not apply to accessories. This warranty applies exclusively to the original purchaser.

One (1) year warranty: Power units for pneumatic, electric, hydraulic and battery-powered tools have a one year warranty. This includes, but is not limited to REED pumps, universal pipe cutter motors, power drives, power bevel tools, threading machines, cordless batteries and chargers.

Five (5) year warranty: Any REED tool not specified under the one (1) year warranty above is warranted under the REED five (5) year warranty.

NO PARTY IS AUTHORIZED TO EXTEND ANY OTHER WARRANTY. NO WARRANTY FOR MERCHANTABILITY OR FITNESS FOR A PARTICULAR PURPOSE SHALL APPLY. No warranty claims will be allowed unless the product in question is received freight prepaid at the REED factory. All warranty claims are limited to repair or replacement, at the option of REED, at no charge to the customer. REED is not liable for any damage of any sort, including incidental and consequential damages. This warranty gives you specific legal rights, and you may also have other rights which vary by state, province or country.

Warranty Effective December 1, 2018

CAUTION: Safety reminders for a professional approach to tool selection and use.

- Proper maintenance of tools is critical to personal safety; worn tools should be repaired or replaced as required.
- Select the correct tool and tool size for the job. Never modify a tool to exceed its intended capacity.
- We recommend the Hand Tools Institute booklets for additional safety tips. Booklets are available from REED or the Hand Tools Institute.



PIPE TOOLS & VISES
SINCE 1896